

## PRODUCT SPECIFICATION

\*Product Name: T8 SMD LED Tube Light ( Super Bright )



**ATTENTION**  
OBSERVE PRECAUTIONS  
FOR HANDLING  
ELECTROSTATIC  
DISCHARGE  
SENSITIVE  
DEVICES



\*Dimension Drawing

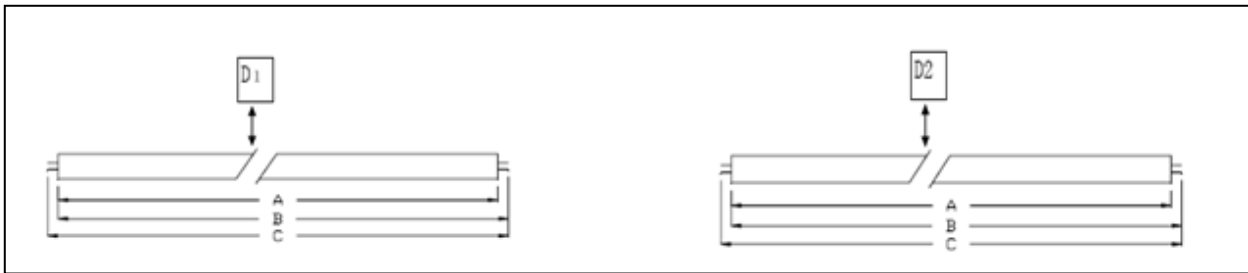

Model	Dimension						
	A	B		C		D1	D2
	Max	Min	Max	Min	Max	Max	Max
T8/8W	589.8	594.0	597.0	601.0	604.0	28	--
T8/10W	589.8	594.0	597.0	601.0	604.0	--	32
T8/15W	1199.6	1203.0	1207.0	1210.0	1213.6	28	--
T8/20W	1199.6	1203.0	1207.0	1210.0	1213.6	28	32
T8/18W	1500	1503.0	1510.0	1510.0	1514.5	28	--

Address:

6/F, 2th building of Hua Feng Technical Industrial Park ,Xi Xiang Town of Bao An District ,Shen Zhen  
 Tel: 86-755-2908205 29082006 29082010 Fax: 86-755-29082009  
 Businsee Hotline :86-755-29082016  
 E-mail: info@ks-light.com  
 Website: Http:// www. ks-light.com Http://www.ks-light.en.alibaba.com

**PRODUCT SPECIFICATION****\*Character**

1. Use the AC85~AC165 & AC165~AC265 two different driver to insure the light decay .
2. Adopt the owner-design led chip for the led light source to insure light decay & high luminance
3. The power factor above 90% , it is more than 2 times than the conventional fluorescent lamp
4. Use the transparent PVC tube as the cover to insure the safety
5. No UV or IR radiation & Lead free
6. CE /FCC & ROHS approval

**\*Operating environment:**

Item	Range	Unit
Operating Voltage	85-165 / 165-265	AC(V)
Operating Frequency	50~60	Hz
Operating Temperature	-20 ~ +50	°C
Storage temperature	-30 ~ +45	°C

**Address:**

6/F,2th building of Hua Feng Technical Industrial Park ,Xi Xiang Town of Bao An District ,Shen Zhen  
Tel: 86-755-2908205 29082006 29082010 Fax: 86-755-29082009  
Businsee Hotline :86-755-29082016  
E-mail: info@ks-light.com  
Website: Http:// www. ks-light.com Http://www.ks-light.en.alibaba.com

**PRODUCT SPECIFICATION**
**\*Electrical / Characteristics**

Model Parameter	Symbol	KS-T806PW8 S2-001 (T8/8W)	KS-T806PW10 S3-001 (T8/10W)	KS-T812PW15 S2-001 (T8/15W)	KS-T812PW20 S3001 (T8/20W)	KS-T815PW18S 2-001 (T8/18W)
Dimension (Length * Dia)	mm	600 X 26	<b>600 x 30</b>	1200 X26	<b>1200 X30</b>	1500 X26
Total Power Consumption	P (W)	8W	10w	15W	20W	18W
Compare conventional Tube	P (W)	20W	30w	40W	Above 40 W	Above 40 W
LedForward current	IF (mA)	18 mA	18mA	18 mA	18 mA	18 mA
LED Qty	PCS	120	162	240	324	300
Color Temperature	TC(K)	WW:3500-5000 PW:5000-6500 CW:7000+	WW:3500-5000 PW:5000-6500 CW:7000+	WW:3500-5000 PW:5000-6500 CW:7000+	WW:3500-5000 PW:5000-6500 CW:7000+	WW:3500-5000 PW:5000-6500 CW:7000+
Led Viewing Angle	2-1/2 $\Theta$	120 $^{\circ}$	120 $^{\circ}$	120 $^{\circ}$	120 $^{\circ}$	120 $^{\circ}$
Luminous Flux	LM	750-850-950	950-1150-1300	1400-1600-1800	1950-2150-2350	1750-1950-2100
illuminance	Lux	1.0 M: 200-300 1.5 M: 150-250	1.0M: 200-300 1.5M: 150-250	1.0M: 250-350 1.5M: 180-280	1.0M: 250-350 1.5M 180-280	1.0M: 250-350 1.5M: 180-280
Light Efficacy	Lm / W	95-105-115	95-105-115	95-105-115	100-110-120	100-110-120
Color Index (Ra)	Ra	70~90	70~90	70~90	70~90	70~90
Operating Life (Hrs)	Hrs	30,000~50,000	30,000~50,000	30,000~50,000	30,000~50,000	30,000~50,000

**Notes: Tolerance of measurement of luminous intensity $\pm$ 15%**

Address:

6/F, 2th building of Hua Feng Technical Industrial Park ,Xi Xiang Town of Bao An District ,Shen Zhen

Tel: 86-755-2908205 29082006 29082010

Fax: 86-755-29082009

Businsee Hotline :86-755-29082016

E-mail: info@ks-light.com

Website: Http:// www. ks-light.com Http://www.ks-light.en.alibaba.com

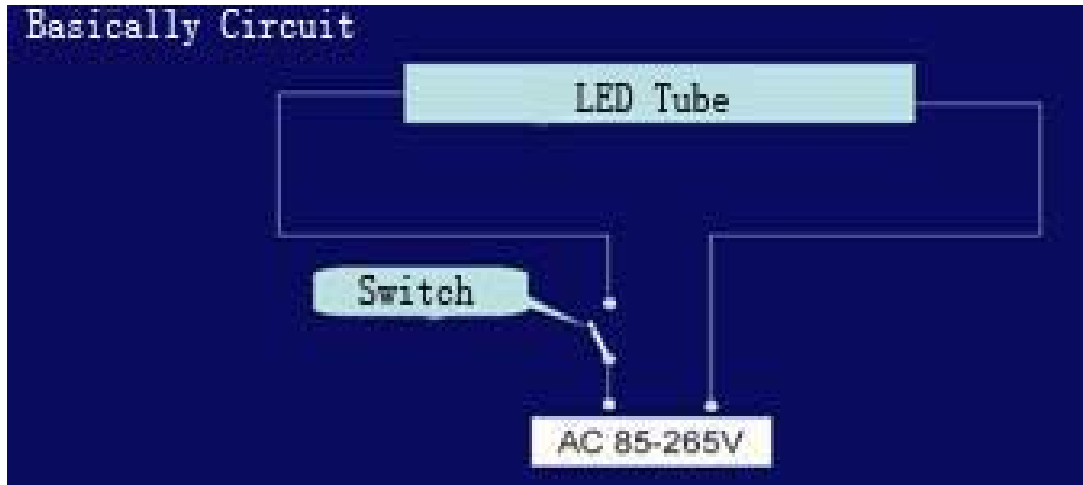
**PRODUCT SPECIFICATION****\*Installation Manual:****\* Basically Circuit**

⌘ When installing the LED Tube to the conventional fluorescent tube hanger, please pay attention to the conventional tube hanger.

A\* When installing LED tube to Inductive ballast tube hanger:

1\* Take out the starter from the inductive ballast tube hanger.

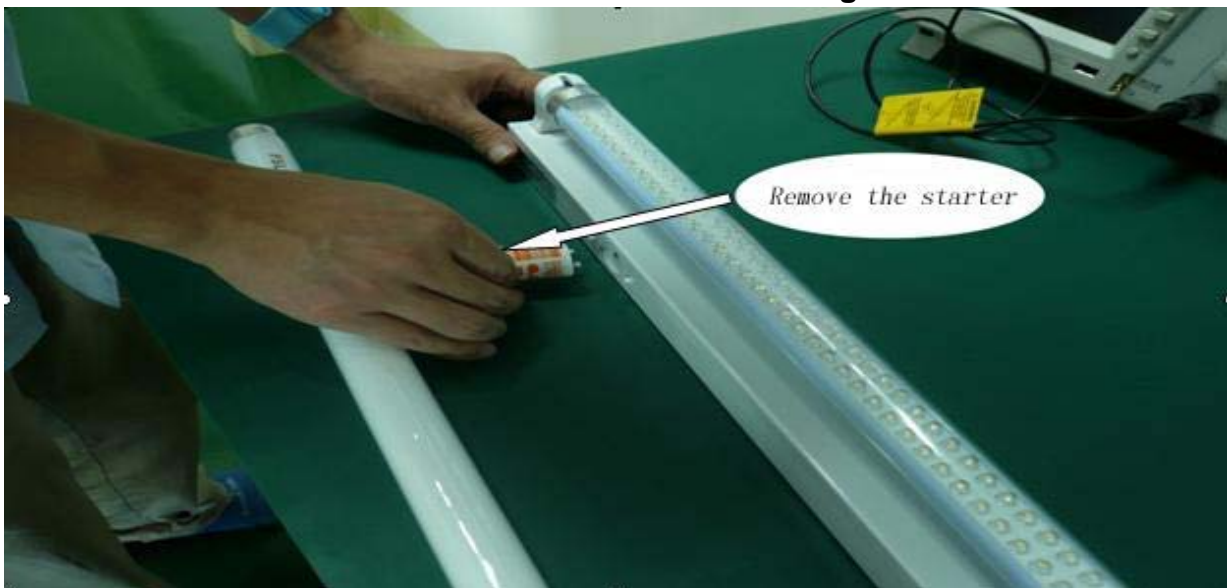

Address:

6/F, 2th building of Hua Feng Technical Industrial Park ,Xi Xiang Town of Bao An District ,Shen Zhen

Tel: 86-755-2908205 29082006 29082010

Fax: 86-755-29082009

Businsee Hotline :86-755-29082016

E-mail: info@ks-light.com

Website: Http:// www. ks-light.com Http://www.ks-light.en.alibaba.com

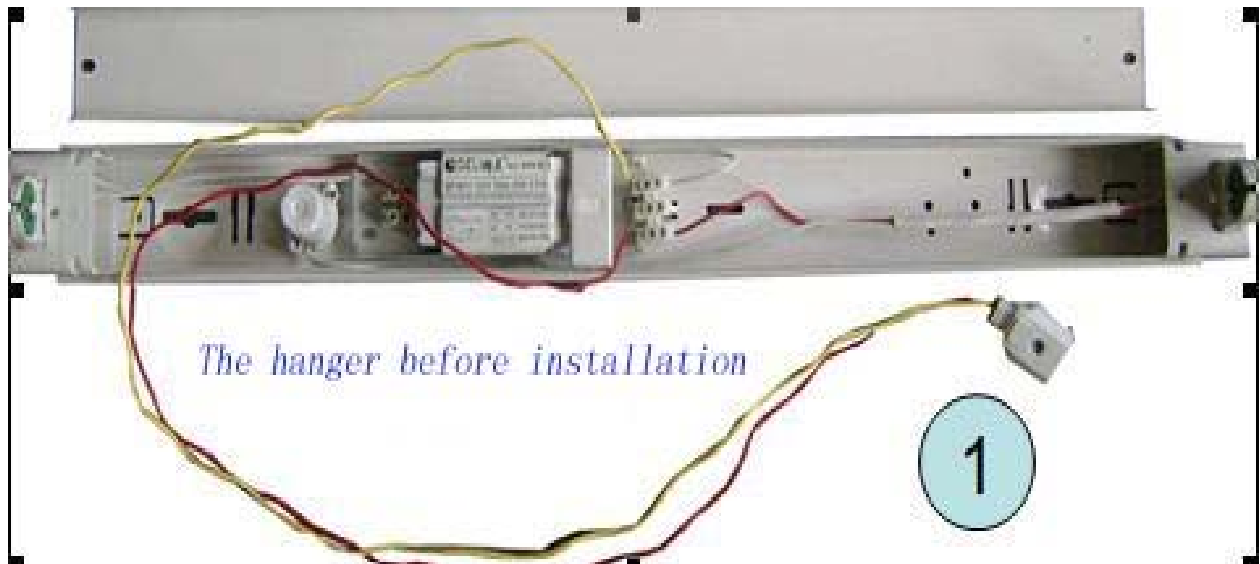
**PRODUCT SPECIFICATION****2\* Install the LED tube into the inductive ballast tube hanger directly****B\* Installing LED tube to Electronic ballast tube hanger:****1. The tube hanger before the installation**

Address:

6/F, 2th building of Hua Feng Technical Industrial Park ,Xi Xiang Town of Bao An District ,Shen Zhen

Tel: 86-755-2908205 29082006 29082010

Fax: 86-755-29082009

Businsee Hotline :86-755-29082016

E-mail: info@ks-light.com

Website: Http:// www. ks-light.com Http://www.ks-light.en.alibaba.com

**PRODUCT SPECIFICATION**

**2\* Take out the starter & electronic ballast from the tube hanger.**

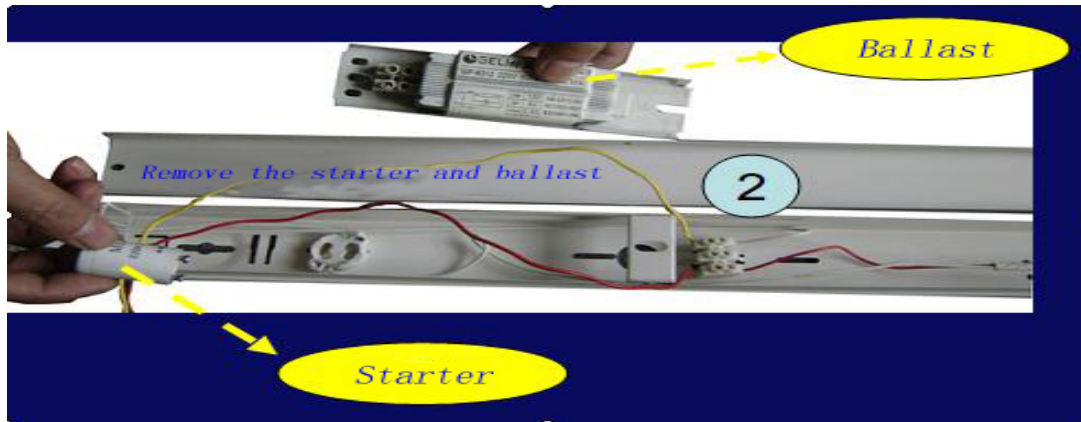

**3\* Connect the anode / cathode directly**

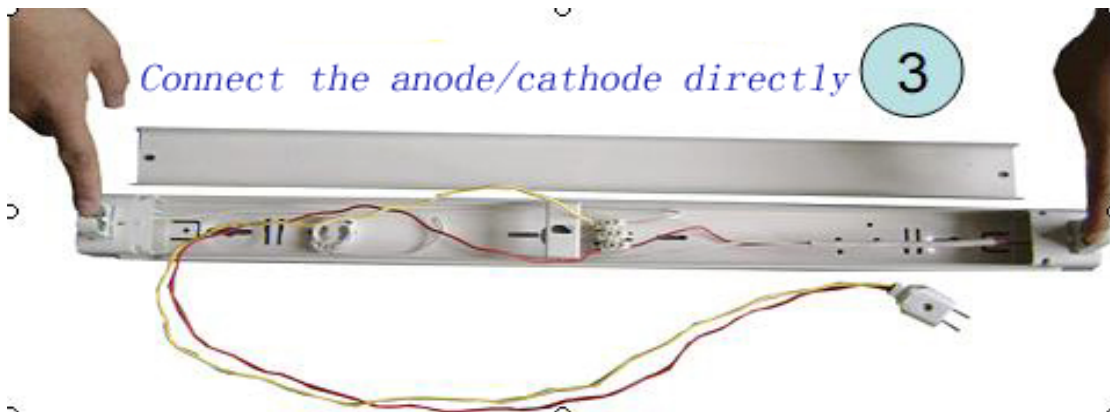

**4\* Put the tube into the Hanger directly for the operating .**



Address:

6/F, 2nd building of Hua Feng Technical Industrial Park, Xi Xiang Town of Bao An District, Shen Zhen

Tel: 86-755-2908205 29082006 29082010

Fax: 86-755-29082009

Business Hotline: 86-755-29082016

E-mail: [info@ks-light.com](mailto:info@ks-light.com)

Website: [Http:// www. ks-light.com](http://www.ks-light.com) [Http://www.ks-light.en.alibaba.com](http://www.ks-light.en.alibaba.com)

## PRODUCT SPECIFICATION

### \*Package :

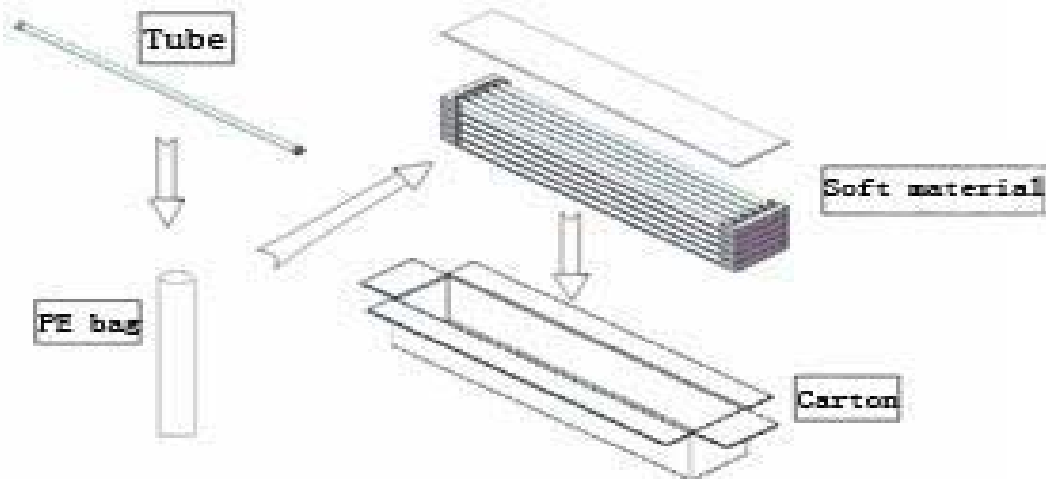

### Detailed Packing Information

Model Number	Product Name	Outer Carton Size (L X W X H)	Qty/Carton (PCS)	N.W	G.W
KS-T806PW8D2-001	T8/8W	670X240X220	25	5.5kg	6.5Kg
KS-T809PW12D2-001	T8/10W	670X240X220	25	5.5kg	6.5Kg
KS-T812PW15D2-001	T8/15W	1270X240X220	25	9.5Kg	12.0Kg
KS-T812PW20D2-002	T8/20W	1270X240X220	25	9.5 Kg	12.0Kg
KS-T815PW18D2-001	T8/18W	1570X240X220	25	10.5Kg	15.0 Kg

#### Address:

6/F, 2th building of Hua Feng Technical Industrial Park ,Xi Xiang Town of Bao An District ,Shen Zhen

Tel: 86-755-2908205 29082006 29082010

Fax: 86-755-29082009

Businsee Hotline :86-755-29082016

E-mail: info@ks-light.com

Website: Http:// www. ks-light.com Http://www.ks-light.en.alibaba.com



**PRODUCT SPECIFICATION**

Address:

6/F, 2th building of Hua Feng Technical Industrial Park ,Xi Xiang Town of Bao An District ,Shen Zhen

Tel: 86-755-2908205 29082006 29082010

Fax: 86-755-29082009

Businsee Hotline :86-755-29082016

E-mail: [info@ks-light.com](mailto:info@ks-light.com)

Website: [Http:// www. ks-light.com](http://www.ks-light.com) [Http://www.ks-light.en.alibaba.com](http://www.ks-light.en.alibaba.com)